

**2004 Mathematics**

**Higher**

**Finalised Marking Instructions**

1. Marks must be assigned in accordance with these marking instructions. In principle, marks are awarded for what is correct, rather than marks deducted for what is wrong.
2. Award one mark for each 'bullet' point. Each error should be underlined in RED at the point in the working where it first occurs, and not at any subsequent stage of the working.
3. The working subsequent to an error must be followed through by the marker with possible full marks for the subsequent working, provided that the difficulty involved is approximately similar. Where, subsequent to an error, the working is eased, a deduction(s) of mark(s) should be made.  
This may happen where a question is divided into parts. In fact, failure to even answer an earlier section does not preclude a candidate from assuming the result of that section and obtaining full marks for a later section.
4. Correct working should be ticked (✓). This is essential for later stages of the SQA procedures. Where working subsequent to an error(s) is correct and scores marks, it should be marked with a crossed tick (✗). In appropriate cases attention may be directed to work which is not quite correct (e.g. bad form) but which has not been penalised, by underlining with a dotted or wavy line.  
Work which is correct but inadequate to score any marks should be corrected with a double cross tick (✘).
5.
  - The total mark for each section of a question should be entered in red in the **outer** right hand margin, opposite the end of the working concerned.
  - Only the mark should be written, **not** a fraction of the possible marks.
  - These marks should correspond to those on the question paper and these instructions.
6. It is of great importance that the utmost care should be exercised in adding up the marks. Where appropriate, all summations for totals and grand totals must be carefully checked.  
Where a candidate has scored zero marks for any question attempted, "0" should be shown against the answer.
7. As indicated on the front of the question paper, full credit should only be given where the solution contains appropriate working. Accept answers arrived at by inspection or mentally where it is possible for the answer so to have been obtained. Situations where you may accept such working will be indicated in the marking instructions.

cont/

8. Do not penalise:
  - working subsequent to a correct answer
  - omission of units
  - bad form
  - legitimate variations in numerical answers
  - correct working in the “wrong” part of a question
9. No piece of work should be scored through - even where a fundamental misunderstanding is apparent early in the answer. Reference should always be made to the marking scheme - answers which are widely off-beam are unlikely to include anything of relevance but in the vast majority of cases candidates still have the opportunity of gaining the odd mark or two provided it satisfies the criteria for the mark(s).
10. If in doubt between two marks, give an intermediate mark, but without fractions. When in doubt between consecutive numbers, give the higher mark.
11. In cases of difficulty covered neither in detail nor in principle in the Instructions, attention may be directed to the assessment of particular answers by making a referral to the P.A. Please see the general instructions for P.A. referrals.
12. No marks should be deducted at this stage for careless or badly arranged work. In cases where the writing or arrangement is very bad, a note may be made on the upper left-hand corner of the front cover of the script.
- 13 **Do not write any comments on the scripts.** A summary of acceptable notation is given on page 4.

#### Summary

Throughout the examination procedures many scripts are remarked. It is essential that markers follow common procedures:

- 1 **Tick** correct working.
- 2 Put a mark in the **right-hand margin to match the marks allocations on the question paper.**
- 3 **Do not** write marks as fractions.
- 4 Put each mark **at the end** of the candidate’s response to the question.
- 5 **Follow through** errors to see if candidates can score marks subsequent to the error.
- 6 **Do not** write any comments on the scripts.

Higher Mathematics : A Guide to Standard Signs and Abbreviations

Remember - No comments on the scripts. Please use the following and nothing else.

Signs

- ✓ The tick. You are not expected to tick every line but of course you must check through the whole of a response.
- ✗ The cross and underline. Underline an error and place a cross at the end of the line.
- ✗ The tick-cross. Use this to show correct work where you are following through subsequent to an error.
- ✗ The double cross-tick. Use this to show correct work but which is inadequate to score any marks.
- ∧ The roof. Use this to show something is missing such as a crucial step in a proof or a 'condition' etc.
- ~ The tilde. Use this to indicate a minor transgression which is not being penalised (such as bad form).
- E Eased. Where working is found correct whilst following through subsequent to an error, the working has been eased sufficiently for a mark not to be awarded.
- BOD Benefit of Doubt. Use this where you have to decide between two consecutive marks and award the higher.

Marks being allotted e.g. (•) would not normally be shown on scripts

			margins
$\frac{dy}{dx} = 4x - 7$ $4x - 7 = 0$ $x = \frac{7}{4}$ $y = 3\frac{7}{8}$	✓ • ✗ ✗ •		2
$C = (1, -1)$ $m = \frac{3 - (-1)}{4 - 1}$ $m_{rad} = \frac{4}{3}$ $m_{tgt} = \frac{-1}{\frac{4}{3}}$ $m_{tgt} = -\frac{3}{4}$ $y - 3 = -\frac{3}{4}(x - 2)$	✗ ✗ • follow through ✗ • ✗ •		3
$x^2 - 3x = 28$ $x = 7$	✓ • ✗	∧	1
$\sin(x) = 0.75 = \text{inv sin}(0.75) = 48.6^\circ$	✓ •	~	1
$\log_3(x - 2) = 1$ $(x - 2) = 3^1$ $x - 2 = 3$ $x = 5$	✗ ✗ • ✗ E		1

All of these are to help us be more consistent and accurate.

It goes without saying that however accurate you are in marking, it is to no avail unless you have added the marks up correctly. Please double check totals!!

1	The point A has coordinates (7, 4). The straight lines with equations $x + 3y + 1 = 0$ and $2x + 5y = 0$ intersect at B.	
	(a) Find the gradient of AB.	<b>3</b>
	(b) Hence show that AB is perpendicular to only one of these two lines.	<b>5</b>

Qu.	part	marks	Grade	Syllabus Code	Calculator class	Source
1	a	3	C	1.1.1	CN	04/15
	b	5	C	1.1.9, 1.1.10		

<p>The Primary Method m/s is based on the following generic m/s. THIS GENERIC M/S MAY BE USED AS AN EQUIVALENCE GUIDE BUT ONLY WHERE A CANDIDATE DOES NOT USE THE PRIMARY METHOD OR ANY ALTERNATIVE METHOD SHOWN IN DETAIL IN THE MARKING SCHEME.</p>	
• <sup>1</sup> ss :	strategy for solving sim. equations
• <sup>2</sup> pd :	process
• <sup>3</sup> pd :	calculate gradient
• <sup>4</sup> ss :	use $m_1.m_2 = -1$
• <sup>5</sup> ss :	arrange in standard form
• <sup>6</sup> ic :	state gradient
• <sup>7</sup> ic :	state gradient
• <sup>8</sup> ic :	complete proof

<p>Primary Method : Give 1 mark for each •</p>	
• <sup>1</sup>	$x = -3y - 1$ and attempt to substitute e.g. $2(-3y - 1) + \dots = 0$
• <sup>2</sup>	$B(5, -2)$
• <sup>3</sup>	$m_{AB} = 3$
	<b>3 marks</b>
• <sup>4</sup>	$m_{AB} = 3 \Rightarrow m_{perp} = -\frac{1}{3}$
• <sup>5</sup>	$y = -\frac{1}{3}x \dots$ stated / implied by • <sup>6</sup>
• <sup>6</sup>	$m_{l_1} = -\frac{1}{3}$
• <sup>7</sup>	$m_{l_2} = -\frac{2}{5}$
• <sup>8</sup>	so only the 1st line is perpendicular to AB
	<b>5 marks</b>

Notes

- For •<sup>1</sup>  
Elimination may be used instead of substitution  
Evidence of a start to elimination would be the appearance of equal coefficients of  $x$  or  $y$ .
- For (a) equating the zeros, neither of the first two marks are available.
- $(5, -2)$  may be obtained by inspection or trial and improvement. If it is justified by checking in both equations, •<sup>1</sup> and •<sup>2</sup> may be awarded. If is not justified in both equations, award neither of the first two marks.
- A general statement about perpendicular lines must have  $m_1.m_2 = -1$  earns no marks
- Candidates who make a mistake in (a) may have to show in (b) that neither line is perpendicular to AB. All five marks are available.

<p>1 Alternative Method for •4 to •8</p>	
• <sup>4</sup>	$y = -\frac{1}{3}x \dots$ may be implied by • <sup>5</sup>
• <sup>5</sup>	$m_{l_1} = -\frac{1}{3}$
• <sup>6</sup>	$m_{l_2} = -\frac{2}{5}$
• <sup>7</sup>	$l_1 : 3 \times -\frac{1}{3} = -1$ so $AB \perp l_1$
• <sup>8</sup>	and $AB$ is not $\perp l_2$
	<b>5 marks</b>

<p>2 Alternative Method for •4 to •8</p>	
• <sup>4</sup>	$m_{AB} = 3 \Rightarrow m_{perp} = -\frac{1}{3}$
• <sup>5</sup>	$y = -\frac{2}{5}x$ stated / implied by • <sup>6</sup>
• <sup>6</sup>	$m_{l_1} = -\frac{2}{5}$
• <sup>7</sup>	$m_{l_2} = -\frac{1}{3}$
• <sup>8</sup>	so only the 2nd line is perpendicular to AB
	<b>5 marks</b>

Continued on page 6

- 1 The point A has coordinates (7, 4). The straight lines with equations  $x + 3y + 1 = 0$  and  $2x + 5y = 0$  intersect at B.
- (a) Find the gradient of AB. **3**
- (b) Hence show that AB is perpendicular to only one of these two lines. **5**

Qu.	part	marks	Grade	Syllabus Code	Calculator class	Source
1	a	3	C	1.1.1	CN	04/15
	b	5	C	1.1.9, 1.1.10		

continued from page 5

3 Alternative Method for •4 to •8
<ul style="list-style-type: none"> <li>•<sup>4</sup> <math>m_{perp} = -\frac{1}{3}</math></li> <li>•<sup>5</sup> strat: find equ. thr' B with gradient <math>-\frac{1}{3}</math></li> <li>•<sup>6</sup> <math>y - (-2) = -\frac{1}{3}(x - 5)</math></li> <li>•<sup>7</sup> leading to <math>3y + x + 1 = 0</math></li> <li>•<sup>8</sup> the first line is the ONLY line perp. to AB</li> </ul> <p style="text-align: right;">5 marks</p>

4 Alternative Method for •4 to •8
<ul style="list-style-type: none"> <li>•<sup>4</sup> <math>y = -\frac{1}{3}x...</math> may be implied by •<sup>5</sup></li> <li>•<sup>5</sup> <math>m_{l_1} = -\frac{1}{3}</math></li> <li>•<sup>6</sup> <math>m_{l_2} = -\frac{2}{5}</math></li> <li>•<sup>7</sup> <math>l_1 : 3 \times -\frac{1}{3} = -1</math> so AB is the <b>ONLY</b> line <math>\perp l_1</math></li> <li>•<sup>8</sup> implied by the "<b>ONLY</b>" at •<sup>7</sup>.</li> </ul> <p style="text-align: right;">5 marks</p>

5 A "Poor" illustration
$\left. \begin{array}{l} y = -\frac{1}{3}x... \\ y = -\frac{2}{5}x \end{array} \right\} 1 \text{ mark}$
$\left. \begin{array}{l} \text{1st equ is perp. to AB} \\ \text{2nd equ is not perp to AB} \end{array} \right\} 1 \text{ mark}$

6 Further illustrations
<p>AB is perp. to <math>x + 3y + 1 = 0</math>                      because <math>3 \times -\frac{1}{3} = -1</math> <span style="float: right;">•<sup>4</sup> only</span>                      [end!]</p>
<p>AB is perp. to <math>x + 3y + 1 = 0</math>                      as its gradient is <math>-\frac{1}{3}</math> <span style="float: right;">•<sup>4</sup> (&amp; •<sup>5</sup>)</span>                      and AB is <math>3 \Leftrightarrow 3 \times -\frac{1}{3} = -1</math>                      all of the above writing <span style="float: right;">•<sup>7</sup></span></p>
<p>AB is perp. to the line <math>y = -\frac{1}{3}...</math> <span style="float: right;">•<sup>5</sup></span>                      because <math>3 \times -\frac{1}{3} = -1</math> <span style="float: right;">•<sup>4</sup></span>                      all of the above writing <span style="float: right;">•<sup>7</sup></span></p>

2	$f(x) = x^3 - x^2 - 5x - 3.$		
	(a) (i)	Show that $(x + 1)$ is a factor of $f(x)$ .	
	(ii)	Hence or otherwise factorise $f(x)$ fully.	<b>5</b>
	(b)	One of the turning points of the graph of $y = f(x)$ lies on the $x$ -axis. Write down the coordinates of this turning point .	<b>1</b>

Qu.	part	marks	Grade	Syllabus Code	Calculator class	Source
2	a	5	C	2.1.3	NC	04/58
	b	1	C	2.1.3		

The Primary Method m/s is based on the following generic m/s. THIS GENERIC M/S MAY BE USED AS AN EQUIVALENCE GUIDE BUT ONLY WHERE A CANDIDATE DOES NOT USE THE PRIMARY METHOD OR ANY ALTERNATIVE METHOD SHOWN IN DETAIL IN THE MARKING SCHEME.

- <sup>1</sup> ss : know to find  $f(-1)$
- <sup>2</sup> ss : start eg synthetic division
- <sup>3</sup> pd : complete to zero remainder
- <sup>4</sup> ic : extract quadratic
- <sup>5</sup> ic : fully factorise
- <sup>6</sup> ic : state coordinates

Primary Method : Give 1 mark for each •

•<sup>1</sup> *know to find*  $f(-1)$

•<sup>2</sup>  $-1$ 

1	-1	-5	-3
	-1		

.

1

•<sup>3</sup>  $-1$ 

1	-1	-5	-3
	-1	2	3

.

1   -2   -3   0

•<sup>4</sup>  $x^2 - 2x - 3$

•<sup>5</sup>  $(x + 1)(x + 1)(x - 3)$

5 marks

•<sup>6</sup>  $(-1, 0)$

1 mark

1 Alternative Method 1 for •1 , •2 and •3

•<sup>1</sup> *know to find*  $f(-1)$

•<sup>2</sup>  $f(-1) = (-1)^3 - (-1)^2 - 5(-1) - 3 = 0$

•<sup>3</sup> *a strategy for finding the quadratic factor*  
*eg inspection, long division, synthetic division*

Notes

1 Treat  $f(x) = (x + 1), (x + 1), (x - 3)$  as bad form

2 •<sup>6</sup> is not available for

“(-1,0) or (3, 0)”

“ $x = - 1$ ”

an unsupported “(0,-1)”

3 Treat 

$x = -1$
$y = \dots = 0$
so point = (0,-1)

 as bad form

3 Find all the values of  $x$  in the interval  $0 \leq x \leq 2\pi$  for which  $\tan^2(x) = 3$ . 4

Qu.	part	marks	Grade	Syllabus Code	Calculator class	Source
3		4	C	1.2.9, 1.2.11	NC	04/85

The Primary Method m/s is based on the following generic m/s. THIS GENERIC M/S MAY BE USED AS AN EQUIVALENCE GUIDE BUT ONLY WHERE A CANDIDATE DOES NOT USE THE PRIMARY METHOD OR ANY ALTERNATIVE METHOD SHOWN IN DETAIL IN THE MARKING SCHEME.

- <sup>1</sup> ss : know to get the square root
- <sup>2</sup> pd : solve trig equation
- <sup>3</sup> pd : solve trig equation
- <sup>4</sup> ic : know there is  $+\sqrt{\quad}$  and  $-\sqrt{\quad}$

Primary Method : Give 1 mark for each •

- <sup>1</sup>  $\tan x = \sqrt{3}$
- <sup>2</sup>  $x = \frac{\pi}{3}$
- <sup>3</sup>  $x = \frac{4\pi}{3}$
- <sup>4</sup>  $\tan x = -\sqrt{3}$  stated explicitly  
and  $x = \frac{2\pi}{3}, \frac{5\pi}{3}$

4 marks

1 Alternative Method for •1 and •2

- <sup>1</sup>  $\tan x = \sqrt{3}$
- <sup>2</sup>  $x = \frac{\pi}{3}$
- <sup>3</sup>  $\tan x = -\sqrt{3}$  and  $x = \frac{2\pi}{3}$
- <sup>4</sup>  $\frac{4\pi}{3}$  and  $\frac{5\pi}{3}$

4 marks

Notes

- 1 Candidates must produce final answers in radians. If their final answer(s) are in degrees then deduct one mark.
- 2 **Cave**  
Candidates who produce the four correct answers from  $\tan(x) = \sqrt{3}$  can only be awarded •<sup>1</sup> and •<sup>2</sup>.
- 3 Do not penalise “correct” answers outside the range  $0 \leq x \leq 2\pi$
- 4 Do **NOT** accept  $\pi + \frac{\pi}{3}$  for  $\frac{4\pi}{3}$ .



4 The diagram shows the graph of  $y = g(x)$ .

(a) Sketch the graph of  $y = -g(x)$ .

(b) On the same diagram sketch the graph of  $y = 3 - g(x)$ .

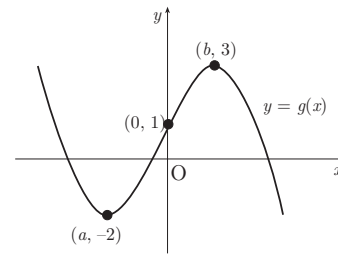

2  
2

Qu.	part	marks	Grade	Syllabus Code	Calculator class	Source
4	a	2	C	1.2.4	CN	04/6
	b	2	C	1.2.4		

The Primary Method m/s is based on the following generic m/s. THIS GENERIC M/S MAY BE USED AS AN EQUIVALENCE GUIDE BUT ONLY WHERE A CANDIDATE DOES NOT USE THE PRIMARY METHOD OR ANY ALTERNATIVE METHOD SHOWN IN DETAIL IN THE MARKING SCHEME.

- <sup>1</sup> ic : sketch transformed graph
- <sup>2</sup> ic : show new coordinates
- <sup>3</sup> ic : sketch transformed graph
- <sup>4</sup> ic : show new coordinates

Primary Method : Give 1 mark for each •

- <sup>1</sup> reflection in  $x$ -axis and any one from  $(0,-1), (a,2), (b,-3)$  clearly annotated
- <sup>2</sup> the remaining two from the above list 2 marks
- <sup>3</sup> translation and any one from  $(0,2), (a,5), (b,0)$  clearly annotated
- <sup>4</sup> the remaining two from the above list 2 marks

**solution**

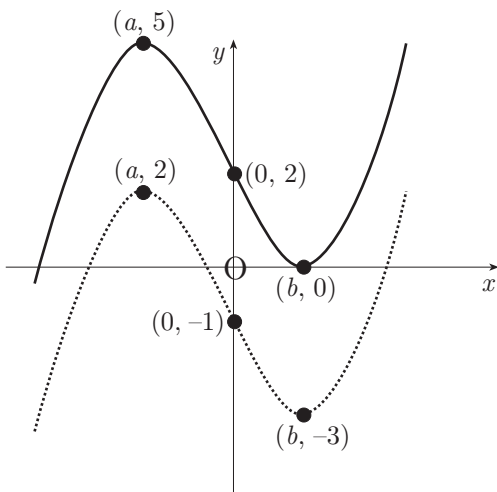

Notes

- 1 For (a), reflection in the  $y$ -axis earns a maximum of 1 out of 2 with all 3 points clearly annotated
- 2 For (b), a translation of  $\begin{pmatrix} 0 \\ -3 \end{pmatrix}$  earns a maximum of 1 out of 2 with all 3 points clearly annotated
- 3 For (b), a translation of  $\begin{pmatrix} \pm 3 \\ 0 \end{pmatrix}$  earns no marks.
- 4 For the annotated points in (a) and (b), accept a superimposed grid.
- 5  $g(x)$  needs to retain its cubic shape for •<sup>1</sup> and •<sup>2</sup>
- 6 In (b) •<sup>3</sup> and •<sup>4</sup> are only available for applying the translation to the resulting graph from (a).

5	A,B, and C have coordinates (-3, 4, 7), (-1, 8, 3), and (0, 10, 1) respectively.	
(a)	Show that A, B, and C are collinear.	3
(b)	Find the coordinates of D such that $\vec{AD} = 4\vec{AB}$ .	2

Qu.	part	marks	Grade	Syllabus Code	Calculator class	Source
5	a	3	C	3.1.7	CN	04/n
	b	2	B	3.1.6		

The Primary Method m/s is based on the following generic m/s. THIS GENERIC M/S MAY BE USED AS AN EQUIVALENCE GUIDE BUT ONLY WHERE A CANDIDATE DOES NOT USE THE PRIMARY METHOD OR ANY ALTERNATIVE METHOD SHOWN IN DETAIL IN THE MARKING SCHEME.

- <sup>1</sup> ss : use vector approach eg for  $\vec{AB}$
- <sup>2</sup> ic : compare two vectors
- <sup>3</sup> ic : complete proof
- <sup>4</sup> pd : find multiple of vector
- <sup>5</sup> ic : interpret vector

2 Alternative Method for •1 and •2

eg

- <sup>1</sup>  $\vec{AB} = \begin{pmatrix} 2 \\ 4 \\ -4 \end{pmatrix} = 2 \begin{pmatrix} 1 \\ 2 \\ -2 \end{pmatrix}$
- <sup>2</sup>  $\vec{AC} = \begin{pmatrix} 3 \\ 6 \\ -6 \end{pmatrix} = 3 \begin{pmatrix} 1 \\ 2 \\ -2 \end{pmatrix}$

3 Alternative Method for •4

- <sup>4</sup>  $d - a = 4(b - a) \Rightarrow d = 4b - 3a$   
or
- <sup>4</sup>  $d - a = 4(b - a) \Rightarrow d - a = \begin{pmatrix} 8 \\ 16 \\ -16 \end{pmatrix}$

Primary Method : Give 1 mark for each •

- <sup>1</sup>  $\vec{AB} = \begin{pmatrix} 2 \\ 4 \\ -4 \end{pmatrix}$
- <sup>2</sup>  $\vec{AC} = \begin{pmatrix} 3 \\ 6 \\ -6 \end{pmatrix} = \frac{3}{2} \times \vec{AB}$
- <sup>3</sup>  $\vec{AB}$  &  $\vec{AC}$  have common direction and common point  
Hence A,B and C collinear

3 marks

- <sup>4</sup>  $\vec{AD} = \begin{pmatrix} 8 \\ 16 \\ -16 \end{pmatrix}$
- <sup>5</sup>  $D = (5, 20, -9)$

2 marks

1 Alternatives Method for •1 and •2

- <sup>1</sup>  $\vec{BC} = \begin{pmatrix} 1 \\ 2 \\ -2 \end{pmatrix}$
- <sup>1</sup>  $\vec{AB} = \begin{pmatrix} 2 \\ 4 \\ -4 \end{pmatrix}$
- <sup>2</sup>  $\vec{AC} = \begin{pmatrix} 3 \\ 6 \\ -6 \end{pmatrix} = 3 \times \vec{BC}$
- <sup>2</sup>  $\vec{BC} = \begin{pmatrix} 1 \\ 2 \\ -2 \end{pmatrix} = \frac{1}{2} \times \vec{AB}$

Notes

1 Treat  $D = \begin{pmatrix} 5 \\ 20 \\ -9 \end{pmatrix}$  as bad form.

2 For •<sup>3</sup> accept **ONLY** “parallel” in lieu of “common direction”

6 Given that  $y = 3\sin(x) + \cos(2x)$ , find  $\frac{dy}{dx}$ .

3

Qu.	part	marks	Grade	Syllabus Code	Calculator class	Source
6		3	B	3.2.1	CN	04/n

The Primary Method m/s is based on the following generic m/s. THIS GENERIC M/S MAY BE USED AS AN EQUIVALENCE GUIDE BUT ONLY WHERE A CANDIDATE DOES NOT USE THE PRIMARY METHOD OR ANY ALTERNATIVE METHOD SHOWN IN DETAIL IN THE MARKING SCHEME.

- <sup>1</sup> pd : process simple derivative
- <sup>2</sup> pd : start to process compound derivative
- <sup>3</sup> ic : complete compound derivative

Primary Method : Give 1 mark for each •

- <sup>1</sup>  $3\cos(x)$
- <sup>2</sup>  $-\sin(2x)$
- <sup>3</sup>  $\times 2$

3 marks

1 Alternative Methods

e.g.

$$y = 3\sin(x) + 2\cos^2(x) - 1$$

- <sup>1</sup>  $3\cos(x)$
- <sup>2</sup>  $4\cos(x)$
- <sup>3</sup>  $\times -\sin(x)$  and no further terms

3 marks

Notes

- 1 For differentiating incorrectly:  
For  $y' = -3\cos(x) + 2\sin(2x)$ , only •<sup>3</sup> may be awarded.
- 2 For  $y' = 3\cos(x) - 2\sin(2x) + c$ , treat the "+c" as bad form.
- 3 For clearly integrating correctly or otherwise:  
Award no marks.
- 4 If you cannot decide whether a candidate has attempted to differentiate or integrate, assume they have attempted to differentiate.

7 Find  $\int_0^2 \sqrt{4x+1} \, dx$ .

5

Qu.	part	marks	Grade	Syllabus Code	Calculator class	Source
7		5	AB	3.2.3	CN	04/52

The Primary Method m/s is based on the following generic m/s. THIS GENERIC M/S MAY BE USED AS AN EQUIVALENCE GUIDE BUT ONLY WHERE A CANDIDATE DOES NOT USE THE PRIMARY METHOD OR ANY ALTERNATIVE METHOD SHOWN IN DETAIL IN THE MARKING SCHEME.

- <sup>1</sup> ic : express in integrable form
- <sup>2</sup> pd : integrate a composite fractional power
- <sup>3</sup> ic : interpret the '4'
- <sup>4</sup> ic : substitute limits
- <sup>5</sup> pd : evaluate

Primary Method : Give 1 mark for each •

- <sup>1</sup>  $(4x+1)^{\frac{1}{2}}$
- <sup>2</sup>  $\frac{1}{\frac{3}{2}}(4x+1)^{\frac{3}{2}}$
- <sup>3</sup>  $\div 4$
- <sup>4</sup>  $\frac{1}{6}(4 \times 2 + 1)^{\frac{3}{2}} - \frac{1}{6}(4 \times 0 + 1)^{\frac{3}{2}}$
- <sup>5</sup>  $\frac{13}{3}$  or equivalent fraction or mixed number

5 marks

1 Common wrong solution

- <sup>1</sup>  $\checkmark \int (4x+1)^{\frac{1}{2}} dx$
  - <sup>2</sup>  $\times \int (4x^{\frac{1}{2}} + 1^{\frac{1}{2}}) dx$
  - <sup>3</sup>  $\times \frac{4x^{\frac{3}{2}}}{\frac{3}{2}} + x$
  - <sup>4</sup>  $\checkmark \left[ \frac{4 \cdot 2^{\frac{3}{2}}}{\frac{3}{2}} + 2 \right] - \left[ \frac{4 \cdot 0^{\frac{3}{2}}}{\frac{3}{2}} + 0 \right]$
  - <sup>5</sup>  $\checkmark \frac{16\sqrt{2}}{3} + 2$
- 3 marks awarded

Notes

1 •<sup>4</sup> is available for substituting the limits correctly into any function except the original one.

eg 
$$\int_0^2 (4x+1)^{\frac{1}{2}} dx$$

$$= \left[ (4x+1)^{\frac{1}{2}} \right]_0^2$$

$$= (4 \times 2 + 1)^{\frac{1}{2}} - (4 \times 0 + 1)^{\frac{1}{2}}$$

$$= 3 - 1$$

$$= 2$$

may be awarded •<sup>1</sup>, not •<sup>2</sup> (no integration)  
 not •<sup>3</sup> (not dealing with  $f(g(x))$ )  
 not •<sup>4</sup> (original function)  
 not •<sup>5</sup> (working eased)

2 For •<sup>5</sup>, **DO NOT accept** answers like  $\frac{\sqrt{729}}{6} - \frac{1}{6}$ .

- 8 (a) Write  $x^2 - 10x + 27$  in the form  $(x + b)^2 + c$ . 2
- (b) Hence show that the function  $g(x) = \frac{1}{3}x^3 - 5x^2 + 27x - 2$  is always increasing. 4

Qu.	part	marks	Grade	Syllabus Code	Calculator class	Source
8	a	2	C	1.2.8	NC	04/37
	b	4	B	1.3.11		

The Primary Method m/s is based on the following generic m/s.  
THIS GENERIC M/S MAY BE USED AS AN EQUIVALENCE GUIDE  
BUT ONLY WHERE A CANDIDATE DOES NOT USE THE PRIMARY  
METHOD OR ANY ALTERNATIVE METHOD SHOWN IN DETAIL IN  
THE MARKING SCHEME.

- <sup>1</sup> pd : deal with the 'b'
- <sup>2</sup> pd : deal with the 'c'
- <sup>3</sup> ss : use differentiation
- <sup>4</sup> pd : differentiate
- <sup>5</sup> ss : use previous working
- <sup>6</sup> ic : complete proof

Primary Method : Give 1 mark for each •

- <sup>1</sup>  $(x - 5)^2 \dots$
- <sup>2</sup>  $(x - 5)^2 + 2$  2 marks
- <sup>3</sup>  $g'(x) =$  *STATED EXPLICITLY*
- <sup>4</sup>  $x^2 - 10x + 27$
- <sup>5</sup>  $(x - 5)^2 + 2$
- <sup>6</sup>  $g'(x) > 0$  for all  $x$   
and so  $g(x)$  increasing 4 marks

1 Alternative Method for •3 to •6

- <sup>3</sup>  $g'(x) =$  *STATED EXPLICITLY*
- <sup>4</sup>  $x^2 - 10x + 27$
- <sup>5</sup>  $b^2 - 4ac = 100 - 108 = -8$
- <sup>6</sup> no roots, concave up,  $g'(x) > 0$   
and thus  $g(x)$  increasing 4 marks

Notes

- 1 For •<sup>6</sup>, accept  $g'(x) > 2$  in lieu of  $g'(x) > 0$
- 2 Evaluating  $g(1), g(2)$  etc or  $g'(1), g'(2)$  etc gains no credit.

9 Solve the equation  $\log_2(x+1) - 2\log_2(3) = 3$ .

4

Qu.	part	marks	Grade	Syllabus Code	Calculator class	Source
9		4	AB	3.3.4	NC	04/57

The Primary Method m/s is based on the following generic m/s. THIS GENERIC M/S MAY BE USED AS AN EQUIVALENCE GUIDE BUT ONLY WHERE A CANDIDATE DOES NOT USE THE PRIMARY METHOD OR ANY ALTERNATIVE METHOD SHOWN IN DETAIL IN THE MARKING SCHEME.

- <sup>1</sup> ic : use log laws
- <sup>2</sup> ic : use log laws
- <sup>3</sup> ic : express in exponential form
- <sup>4</sup> pd : process

Primary Method : Give 1 mark for each •

- <sup>1</sup>  $-\log_2 3^2$
- <sup>2</sup>  $\log_2 \left( \frac{x+1}{3^2} \right) = 3$
- <sup>3</sup>  $\frac{x+1}{3^2} = 2^3$
- <sup>4</sup>  $x = 71$

4 marks

1 Alternative Method

- <sup>1</sup>  $\log_2(x+1) - 2\log_2 3 = 3\log_2 2$
- <sup>2</sup>  $\log_2(x+1) = \log_2 2^3 + \log_2 3^2$
- <sup>3</sup>  $\log_2(x+1) = \log_2(2^3 \times 3^2)$
- <sup>4</sup>  $x = 71$

4 marks

10 In the diagram,  
 angle DEC = angle CEB =  $x^\circ$  and  
 angle CDE = angle BEA =  $90^\circ$ . CD = 1 unit; DE = 3 units.  
 By writing angle DEA in terms of  $x^\circ$ , find the exact value of  $\cos(\widehat{DEA})$ .

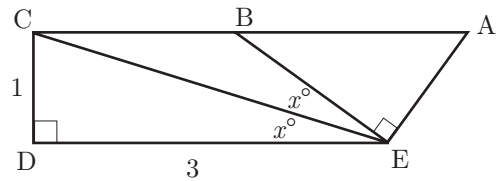

7

Qu. 10	part	marks 7	Grade B	Syllabus Code 2.3.2, 2.3.3	Calculator class CN	Source 04/33
--------	------	---------	---------	----------------------------	---------------------	--------------

The Primary Method m/s is based on the following generic m/s.  
 THIS GENERIC M/S MAY BE USED AS AN EQUIVALENCE GUIDE  
 BUT ONLY WHERE A CANDIDATE DOES NOT USE THE PRIMARY  
 METHOD OR ANY ALTERNATIVE METHOD SHOWN IN DETAIL IN  
 THE MARKING SCHEME.

- <sup>1</sup> ic : interpret diagram
- <sup>2</sup> pd : expand trig expression
- <sup>3</sup> pd : simplify
- <sup>4</sup> ss : use appropriate formula
- <sup>5</sup> pd : process
- <sup>6</sup> ic : interpret
- <sup>7</sup> pd : simplify

Primary Method : Give 1 mark for each •

- <sup>1</sup>  $\widehat{DEA} = (2x^\circ + 90^\circ)$
- <sup>2</sup>  $\cos(2x^\circ)\cos(90^\circ) - \sin(2x^\circ)\sin(90^\circ)$
- <sup>3</sup>  $-\sin(2x^\circ)$
- <sup>4</sup>  $-2\sin(x^\circ)\cos(x^\circ)$
- <sup>5</sup>  $CE = \sqrt{1^2 + 3^2} = \sqrt{10}$  *stated / implied by* •6
- <sup>6</sup>  $\sin(x^\circ) = \left(\frac{1}{\sqrt{10}}\right)$   
*and*  $\cos(x^\circ) = \frac{3}{\sqrt{10}}$
- <sup>7</sup>  $\cos \widehat{DEA} = -2\left(\frac{1}{\sqrt{10}}\right)\left(\frac{3}{\sqrt{10}}\right) = -\frac{6}{10}$

7 marks

Note

- 1 Although unusual, it would be perfectly acceptable for a candidate to go from •<sup>1</sup> to •<sup>3</sup> without expanding (via knowledge of transformations). In this case •<sup>2</sup> would awarded by default.

2 another common wrong solution

- <sup>1</sup> ✓  $\widehat{DEA} = (2x^\circ + 90^\circ)$   
 $\cos(2x^\circ + 90^\circ)$
- <sup>2</sup> ×  $\cos(2x^\circ) + \cos(90^\circ)$
- <sup>3</sup> ×  $\cos(2x^\circ)$  *[working eased]*
- <sup>4</sup> ✓ *eg*  $2\cos^2 x - 1$
- <sup>5</sup> ✓  $CE = \sqrt{1^2 + 3^2} = \sqrt{10}$  *stated / implied by* •6
- <sup>6</sup> ✓  $\cos(x^\circ) = \frac{3}{\sqrt{10}}$
- <sup>7</sup> ✓  $\cos \widehat{DEA} = 2\left(\frac{3}{\sqrt{10}}\right)\left(\frac{3}{\sqrt{10}}\right) - 1 = \frac{8}{10}$

5 marks awarded

1 common wrong solution

- <sup>1</sup> ✓  $\widehat{DEA} = (2x^\circ + 90^\circ)$
- <sup>2</sup> ✓  $\cos(2x^\circ)\cos(90^\circ) - \sin(2x^\circ)\sin(90^\circ)$   
 $\cos(2x^\circ) \times 1 - \sin(2x^\circ) \times 0$
- <sup>3</sup> ×  $\cos(2x^\circ)$
- <sup>4</sup> ✓ *eg*  $2\cos^2 x - 1$
- <sup>5</sup> ✓  $CE = \sqrt{1^2 + 3^2} = \sqrt{10}$  *stated / implied by* •6
- <sup>6</sup> ✓  $\cos(x^\circ) = \frac{3}{\sqrt{10}}$
- <sup>7</sup> ✓  $\cos \widehat{DEA} = 2\left(\frac{3}{\sqrt{10}}\right)\left(\frac{3}{\sqrt{10}}\right) - 1 = \frac{8}{10}$

6 marks awarded

11 The diagram shows a parabola passing through the points (0, 0), (1, -6) and (2, 0).

(a) The equation of the parabola is of the form  $y = ax(x - b)$ .

Find the values of  $a$  and  $b$ .

(b) This parabola is the graph of  $y = f'(x)$ .

Given that  $f(1) = 4$ , find the formula for  $f(x)$ .

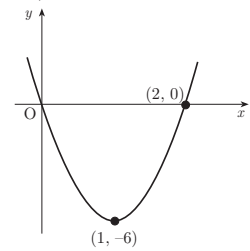

3

5

Qu.	part	marks	Grade	Syllabus Code	Calculator class	Source
11	a	3	B	2.1.10	CN	04/57
	b	5	A	2.2.8		

The Primary Method m/s is based on the following generic m/s. THIS GENERIC M/S MAY BE USED AS AN EQUIVALENCE GUIDE BUT ONLY WHERE A CANDIDATE DOES NOT USE THE PRIMARY METHOD OR ANY ALTERNATIVE METHOD SHOWN IN DETAIL IN THE MARKING SCHEME.

- <sup>1</sup> ss : use parabolic form
- <sup>2</sup> pd : substitute
- <sup>3</sup> pd : process
- <sup>4</sup> ss : know to integrate
- <sup>5</sup> pd : express in integrable form
- <sup>6</sup> pd : integrate
- <sup>7</sup> ss : introduce constant and substitute
- <sup>8</sup> pd : process

Primary Method : Give 1 mark for each •

- <sup>1</sup>  $b = 2$  or  $y = ax(x - 2)$
- <sup>2</sup> substitute (1, -6)
- <sup>3</sup>  $a = 6$
- <sup>4</sup>  $f(x) = \int (6x(x - 2))dx$
- <sup>5</sup>  $\int (6x^2 - 12x)dx$
- <sup>6</sup>  $2x^3 - 6x^2$
- <sup>7</sup>  $4 = 2 \times 1^3 - 6 \times 1^2 + c$
- <sup>8</sup>  $c = 8$

3 marks

5 marks

Notes

- 1 In the primary method, •3 must be justified.  
A “guess and check” would be acceptable ie guess  $a = 6$  then check that (1, -6) fits the equation.
- 2 In the primary method, •5 is only available if an intention to integrate has been indicated.
- 3 For candidates who fail to complete (a) but produce values for a and b ex nihilo, 5 marks are available in (b). A deduction of 1 mark may be made if their choice eases the working.
- 4 For candidates who retain “a” and “b” in part (b), marks •<sup>4</sup> to •<sup>7</sup> are available.
- 5 **CAVE**

$$\int_0^2 6x(x - 2)dx = \left[ 2x^3 - 6x^2 \right]_0^2 = -8 \text{ may be awarded } \bullet^4, \bullet^5 \text{ and } \bullet^6.$$

1 Alternative Method for •1 to •3

- <sup>1</sup> two simultaneous equations  
 $2a(2 - b) = 0$  and  $a(1 - b) = -6$
- <sup>2</sup>  $b = 2$
- <sup>3</sup>  $a = 6$

3 marks

2 Alternative Method for •1 to •3

- <sup>1</sup>  $y = k(x - 1)^2 - 6$
- <sup>2</sup>  $0 = k(2 - 1)^2 - 6 \Rightarrow k = 6$
- <sup>3</sup>  $y = 6(x - 1)^2 - 6 \Rightarrow y = 6x(x - 2)$

3 marks



S1 The IQs of a group of students were measured and the scores recorded in the stem-and-leaf diagram as shown.  
Identify any outliers.

*replacing qu.5 (in position 1)*

IQs of a group of students		
10	2 3 5 5 6 8 8	4
	9	
11	0 0 2 3 5 6 7	
	9	
12	1 3	
13	2 6	
$n=20$	10   2	means 102

Qu.	part	marks	Grade	Syllabus Code	Calculator class	Source
S1		4	C	4.1.2, 4.1.3	CN	04/61

The Primary Method m/s is based on the following generic m/s.  
THIS GENERIC M/S MAY BE USED AS AN EQUIVALENCE GUIDE  
BUT ONLY WHERE A CANDIDATE DOES NOT USE THE PRIMARY  
METHOD OR ANY ALTERNATIVE METHOD SHOWN IN DETAIL IN  
THE MARKING SCHEME.

- <sup>1</sup> pd : calculate quartiles
- <sup>2</sup> ss : know how to calculate fences
- <sup>3</sup> pd : calculate fence/interpret outlier
- <sup>4</sup> pd : calculate fence/interpret outlier

Primary Method : Give 1 mark for each •

- <sup>1</sup>  $Q_1 = 107, Q_3 = 118$
- <sup>2</sup> *eg lower fence*  $= Q_1 - 1.5(Q_3 - Q_1)$
- <sup>3</sup> *fence*  $= 90.5$
- <sup>4</sup> *fence*  $= 134.5$  & *136 is outlier*

4 marks

S2 Calculate the mean and variance of the discrete random variable  $X$  whose probability distribution is as follows:

$x$	0	1	2	3	<b>6</b>
$P(X = x)$	0.4	0.3	0.2	0.1	

*replacing qu.6*

Qu.	part	marks	Grade	Syllabus Code	Calculator class	Source
S2		6	C	4.2.12	NC	04/66

The Primary Method m/s is based on the following generic m/s. THIS GENERIC M/S MAY BE USED AS AN EQUIVALENCE GUIDE BUT ONLY WHERE A CANDIDATE DOES NOT USE THE PRIMARY METHOD OR ANY ALTERNATIVE METHOD SHOWN IN DETAIL IN THE MARKING SCHEME.

- <sup>1</sup> ss : know and state rule for mean
- <sup>2</sup> pd : calculate mean
- <sup>3</sup> ss : know/state rule for variance
- <sup>4</sup> ss : know how to find  $E(X^2)$
- <sup>5</sup> pd : calculate  $E(X^2)$
- <sup>6</sup> pd : calculate variance

Primary Method : Give 1 mark for each •

- <sup>1</sup>  $E(X) = \sum xp(x)$
- <sup>2</sup>  $\sum xp(x) = 1$
- <sup>3</sup>  $V(X) = E(X^2) - (E(X))^2$
- <sup>4</sup>  $E(X^2) = \sum x^2 p(x)$
- <sup>5</sup>  $\sum x^2 p(x) = 2$
- <sup>6</sup>  $V(X) = 1$

6 marks

- S3 The committee of New Tron Golf Club consists of 15 men and 10 women which reflects the proportions of men and women who are members of the club.
- It is agreed to send a delegation of 10 committee members to a local planning meeting. The members of the delegation are to be chosen at random and will consist of 6 men and 4 women.
- What is the probability that both committee members Mr Hook and Miss Green will be selected? 4

*replacing qu. 7*

Qu.	part	marks	Grade	Syllabus Code	Calculator class	Source
S3		4	C	4.2.3, 4.2.7	NC	04/67

The Primary Method m/s is based on the following generic m/s. THIS GENERIC M/S MAY BE USED AS AN EQUIVALENCE GUIDE BUT ONLY WHERE A CANDIDATE DOES NOT USE THE PRIMARY METHOD OR ANY ALTERNATIVE METHOD SHOWN IN DETAIL IN THE MARKING SCHEME.

- <sup>1</sup> ic : interpret probability
- <sup>2</sup> ic : interpret probability
- <sup>3</sup> ss : know to multiply for independent events
- <sup>4</sup> pd : process

Primary Method : Give 1 mark for each •

- <sup>1</sup>  $P(\text{man}) = \frac{6}{15}$
- <sup>2</sup>  $P(\text{lady}) = \frac{4}{10}$
- <sup>3</sup> multiply
- <sup>4</sup>  $\frac{6}{15} \times \frac{4}{10} = \frac{4}{25}$

4 marks

1 Alternative Method

- <sup>1</sup> eg  ${}^{15}C_6$
- <sup>2</sup>  ${}^{15}C_6 \times {}^{10}C_4$
- <sup>3</sup>  ${}^{14}C_5 \times {}^9C_3$
- <sup>4</sup>  $\frac{\frac{14!}{5!9!} \cdot \frac{9!}{3!6!}}{\frac{15!}{6!9!} \cdot \frac{10!}{4!6!}} = \frac{4}{25}$

4 marks

S4 The cumulative distribution function for a random variable  $X$  is given by

$$F(x) = \begin{cases} \frac{1}{32}x^2(6-x) & 0 \leq x \leq 4 \\ 0 & \text{otherwise} \end{cases}$$

Show that the median is 2.

**3**

*replacing qu.9*

Qu.	part	marks	Grade	Syllabus Code	Calculator class	Source
S4		3	AB	4.3.3, 4.3.5, 2.1.3	NC	04/70

The Primary Method m/s is based on the following generic m/s.  
THIS GENERIC M/S MAY BE USED AS AN EQUIVALENCE GUIDE  
BUT ONLY WHERE A CANDIDATE DOES NOT USE THE PRIMARY  
METHOD OR ANY ALTERNATIVE METHOD SHOWN IN DETAIL IN  
THE MARKING SCHEME.

- <sup>1</sup> ss : know where median is
- <sup>2</sup> pd : substitute
- <sup>3</sup> ic : interpret result

Primary Method : Give 1 mark for each •

- <sup>1</sup>  $F(\text{median}) = \frac{1}{2}$
- <sup>2</sup>  $F(2) = \frac{1}{32} \times 2^2 \times (6-2)$
- <sup>3</sup>  $F(2) = \frac{1}{2}$ , hence median = 2

*3 marks*

1. Marks must be assigned in accordance with these marking instructions. In principle, marks are awarded for what is correct, rather than marks deducted for what is wrong.
2. Award one mark for each 'bullet' point. Each error should be underlined in RED at the point in the working where it first occurs, and not at any subsequent stage of the working.
3. The working subsequent to an error must be followed through by the marker with possible full marks for the subsequent working, provided that the difficulty involved is approximately similar. Where, subsequent to an error, the working is eased, a deduction(s) of mark(s) should be made.  
This may happen where a question is divided into parts. In fact, failure to even answer an earlier section does not preclude a candidate from assuming the result of that section and obtaining full marks for a later section.
4. Correct working should be ticked (✓). This is essential for later stages of the SQA procedures. Where working subsequent to an error(s) is correct and scores marks, it should be marked with a crossed tick (✗). In appropriate cases attention may be directed to work which is not quite correct (e.g. bad form) but which has not been penalised, by underlining with a dotted or wavy line.  
Work which is correct but inadequate to score any marks should be corrected with a double cross tick (✘).
5.
  - The total mark for each section of a question should be entered in red in the **outer** right hand margin, opposite the end of the working concerned.
  - Only the mark should be written, **not** a fraction of the possible marks.
  - These marks should correspond to those on the question paper and these instructions.
6. It is of great importance that the utmost care should be exercised in adding up the marks. Where appropriate, all summations for totals and grand totals must be carefully checked.  
Where a candidate has scored zero marks for any question attempted, "0" should be shown against the answer.
7. As indicated on the front of the question paper, full credit should only be given where the solution contains appropriate working. Accept answers arrived at by inspection or mentally where it is possible for the answer so to have been obtained. Situations where you may accept such working will be indicated in the marking instructions.

cont/

8. Do not penalise:
  - working subsequent to a correct answer
  - omission of units
  - bad form
  - legitimate variations in numerical answers
  - correct working in the “wrong” part of a question
9. No piece of work should be scored through - even where a fundamental misunderstanding is apparent early in the answer. Reference should always be made to the marking scheme - answers which are widely off-beam are unlikely to include anything of relevance but in the vast majority of cases candidates still have the opportunity of gaining the odd mark or two provided it satisfies the criteria for the mark(s).
10. If in doubt between two marks, give an intermediate mark, but without fractions. When in doubt between consecutive numbers, give the higher mark.
11. In cases of difficulty covered neither in detail nor in principle in the Instructions, attention may be directed to the assessment of particular answers by making a referral to the P.A. Please see the general instructions for P.A. referrals.
12. No marks should be deducted at this stage for careless or badly arranged work. In cases where the writing or arrangement is very bad, a note may be made on the upper left-hand corner of the front cover of the script.
- 13 **Do not write any comments on the scripts.** A summary of acceptable notation is given on page 4.

#### Summary

Throughout the examination procedures many scripts are remarked. It is essential that markers follow common procedures:

- 1 **Tick** correct working.
- 2 Put a mark in the **right-hand margin to match the marks allocations on the question paper.**
- 3 **Do not** write marks as fractions.
- 4 Put each mark **at the end** of the candidate’s response to the question.
- 5 **Follow through** errors to see if candidates can score marks subsequent to the error.
- 6 **Do not** write any comments on the scripts.

Higher Mathematics : A Guide to Standard Signs and Abbreviations

Remember - No comments on the scripts. Please use the following and nothing else.

Signs

- ✓ The tick. You are not expected to tick every line but of course you must check through the whole of a response.
- ✗ The cross and underline. Underline an error and place a cross at the end of the line.
- ✗ The tick-cross. Use this to show correct work where you are following through subsequent to an error.
- ✗ The double cross-tick. Use this to show correct work but which is inadequate to score any marks.
- ∧ The roof. Use this to show something is missing such as a crucial step in a proof or a 'condition' etc.
- ˜ The tilde. Use this to indicate a minor transgression which is not being penalised (such as bad form).
- E Eased. Where working is found correct whilst following through subsequent to an error, the working has been eased sufficiently for a mark not to be awarded.
- BOD Benefit of Doubt. Use this where you have to decide between two consecutive marks and award the higher.

Marks being allotted e.g. (•) would not normally be shown on scripts

			margins
$\frac{dy}{dx} = 4x - 7$	✓ •		
$4x - 7 = 0$	✗		
$x = \frac{7}{4}$			
$y = 3\frac{7}{8}$	✗ •		2
$C = (1, -1)$	✗		
$m = \frac{3 - (-1)}{4 - 1}$			
$m_{rad} = \frac{4}{3}$	✗ • follow through		
$m_{tgt} = \frac{-1}{\frac{4}{3}}$			
$m_{tgt} = -\frac{3}{4}$	✗ •		
$y - 3 = -\frac{3}{4}(x - 2)$	✗ •		3
$x^2 - 3x = 28$	✓ •		
$x = 7$ ∧	✗		1
$\sin(x) = 0.75 = \text{inv sin}(0.75) = 48.6^\circ$	✓ •		1
$\log_3(x - 2) = 1$	✗		
$(x - 2) = 3^1$	✗ •		
$x - 2 = 3$			
$x = 5$	✗ E		1

All of these are to help us be more consistent and accurate.

It goes without saying that however accurate you are in marking, it is to no avail unless you have added the marks up correctly. Please double check totals!!

1 (a) The diagram shows line OA with equation  $x - 2y = 0$ .  
 The angle between OA and the  $x$ -axis is  $a^\circ$ .  
 Find the value of  $a$ . **3**

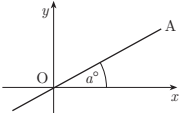

(b) The second diagram shows lines OA and OB. The angle between these two lines is  $30^\circ$ .  
 Calculate the gradient of line OB correct to 1 decimal place. **1**

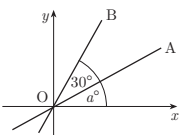

Qu.	part	marks	Grade	Syllabus Code	Calculator class	Source
1	a	3	C	1.1.3	CR	04/81
	b	1	C	1.1.3		

The Primary Method m/s is based on the following generic m/s. THIS GENERIC M/S MAY BE USED AS AN EQUIVALENCE GUIDE BUT ONLY WHERE A CANDIDATE DOES NOT USE THE PRIMARY METHOD OR ANY ALTERNATIVE METHOD SHOWN IN DETAIL IN THE MARKING SCHEME.

- <sup>1</sup> ic : find gradient of a line
- <sup>2</sup> ss : know gradient = tan(angle) and apply
- <sup>3</sup> pd : process
- <sup>4</sup> pd : process angle = tan<sup>-1</sup>(angle)

Primary Method : Give 1 mark for each •

- <sup>1</sup> gradient =  $\frac{1}{2}$
- <sup>2</sup>  $\tan a^\circ = \text{gradient}$  stated or implied by •<sup>3</sup>
- <sup>3</sup>  $\tan^{-1}\left(\frac{1}{2}\right) = 26.6^\circ$  3 marks
- <sup>4</sup>  $m_{OB} = \tan(30 + 26.6)^\circ = 1.5$  1 mark

1	Common Error no.1
$m = -2$	× •1
$\tan a^\circ = m$	✓ •2
$a = \tan^{-1}(-2) = 116.6$	✓ •3

2	Common Error no.2
$m = 1$	× •1
$\tan a^\circ = m$	✓ •2
$a = \tan^{-1}(1) = 45$	✓ •3

3	Common Error no.3
$m = -2$	× •1
$\tan a^\circ = m$	✓ •2
$a = \tan^{-1}(-2) = -63.4 \text{ or } 63.4$	× •3

Notes

- 1 Accept any answer in (a) rounded correctly, so that e.g. if  $a = 27^\circ$  (OK)  
 $m_{OB} = \tan(30 + 27)^\circ = 1.5$
- 2 A candidate who states  $m = \tan \theta$ , and does not go on to use it, cannot be awarded •2.
- 3 Treat  $\tan\left(\frac{1}{2}\right) = 26.6^\circ$  as very bad form.
- 4 In (b) do not penalise “not rounding to 1 d.p.” but accept any correct answer which rounds to 1.5



2 P, Q and R have coordinates (1, 3, -1), (2, 0, 1) and (-3, 1, 2) respectively.

- (a) Express the vectors  $\vec{QP}$  and  $\vec{QR}$  in component form. 2
- (b) Hence or otherwise find the size of angle PQR. 5

Qu.	part	marks	Grade	Syllabus Code	Calculator class	Source
2	a	2	C	3.1.8	CR	04/117
	b	5	C	3.1.9, 3.1.11		

The Primary Method m/s is based on the following generic m/s. THIS GENERIC M/S MAY BE USED AS AN EQUIVALENCE GUIDE BUT ONLY WHERE A CANDIDATE DOES NOT USE THE PRIMARY METHOD OR ANY ALTERNATIVE METHOD SHOWN IN DETAIL IN THE MARKING SCHEME.

- <sup>1</sup> ic : interpret coordinates to vectors
- <sup>2</sup> ic : interpret coordinates to vectors
- <sup>3</sup> ss : know to use eg scalar product
- <sup>4</sup> pd : process scalar product
- <sup>5</sup> pd : process length
- <sup>6</sup> pd : process length
- <sup>7</sup> pd : process angle

Note

1 in (a)

For calculating  $\vec{PQ}$  and  $\vec{RQ}$ , award 1 mark (out of 2)

2 in (a)

Treat e.g. (-1, 3, -2) as bad form

3 For candidates who do not attempt •7 : the formula quoted at •3 in both methods must relate to the labelling in the question to earn •3

Primary Method : Give 1 mark for each •

•<sup>1</sup>  $\vec{QP} = \begin{pmatrix} -1 \\ 3 \\ -2 \end{pmatrix}$

•<sup>2</sup>  $\vec{QR} = \begin{pmatrix} -5 \\ 1 \\ 1 \end{pmatrix}$

2 marks

•<sup>3</sup>  $\cos PQR = \frac{\vec{QP} \cdot \vec{QR}}{|\vec{QP}| |\vec{QR}|}$  stated or implied by •7

•<sup>4</sup>  $\vec{QP} \cdot \vec{QR} = 6$

•<sup>5</sup>  $|\vec{QP}| = \sqrt{14}$

•<sup>6</sup>  $|\vec{QR}| = \sqrt{27}$

•<sup>7</sup>  $P\hat{Q}R = 72.0^\circ$

5 marks

Alternative Method 1 for •3 and •7

•<sup>3</sup>  $\cos P\hat{Q}R = \frac{p^2 + r^2 - q^2}{2pr}$  stated or implied by •7

•<sup>4</sup>  $q = \sqrt{29}$

•<sup>5</sup>  $r = \sqrt{14}$

•<sup>6</sup>  $p = \sqrt{27}$

•<sup>7</sup>  $P\hat{Q}R = 72.0^\circ$

5 marks

CONTINUED

2 P, Q and R have coordinates (1, 3, -1), (2, 0, 1) and (-3, 1, 2) respectively.

(a) Express the vectors  $\vec{QP}$  and  $\vec{QR}$  in component form.

2

(b) Hence or otherwise find the size of angle PQR.

5

Qu.	part	marks	Grade	Syllabus Code	Calculator class	Source
2	a	2	C	3.1.8	CR	04/117
	b	5	C	3.1.9, 3.1.11		

3 Common errors no.1

•<sup>3</sup>  $\cos POR = \frac{\vec{OP} \cdot \vec{OR}}{|\vec{OP}| |\vec{OR}|}$  stated or implied by •7

•<sup>4</sup>  $\vec{OP} \cdot \vec{OR} = -2$

•<sup>5</sup>  $|\vec{OP}| = \sqrt{11}$

•<sup>6</sup>  $|\vec{OR}| = \sqrt{14}$

•<sup>7</sup>  $\hat{P}OR = 99.3^\circ$  or  $1.733^\circ$

4 marks awarded : deduct 1 per error

4 Common errors no.2

•<sup>3</sup>  $\cos QOR = \frac{\vec{OQ} \cdot \vec{OR}}{|\vec{OQ}| |\vec{OR}|}$  stated or implied by •7

•<sup>4</sup>  $\vec{OQ} \cdot \vec{OR} = -4$

•<sup>5</sup>  $|\vec{OQ}| = \sqrt{5}$

•<sup>6</sup>  $|\vec{OR}| = \sqrt{14}$

•<sup>7</sup>  $\hat{Q}OR = 118.6^\circ$  or  $2.069^\circ$

3 marks awarded : deduct 1 per error

5 Common errors no.3

•<sup>3</sup>  $\cos QOP = \frac{\vec{OQ} \cdot \vec{OP}}{|\vec{OQ}| |\vec{OP}|}$  stated or implied by •7

•<sup>4</sup>  $\vec{OQ} \cdot \vec{OP} = 1$

•<sup>5</sup>  $|\vec{OQ}| = \sqrt{11}$

•<sup>6</sup>  $|\vec{OP}| = \sqrt{5}$

•<sup>7</sup>  $\hat{Q}OR = 82.3^\circ$  or  $1.436^\circ$

3 marks awarded : deduct 1 per error

6 Common errors no.4

•<sup>3</sup>  $\cos \hat{P}RQ = \frac{\vec{RP} \cdot \vec{RQ}}{|\vec{RP}| |\vec{RQ}|}$  stated or implied by •7

•<sup>4</sup>  $\vec{RP} \cdot \vec{RQ} = 21$

•<sup>5</sup>  $|\vec{RP}| = \sqrt{29}$

•<sup>6</sup>  $|\vec{RQ}| = \sqrt{27}$

•<sup>7</sup>  $\hat{P}RQ = 41.4^\circ$  or  $0.722^\circ$

3 marks awarded : deduct 1 per error

7 Common errors no.5

•<sup>3</sup>  $\cos \hat{R}PQ = \frac{\vec{PR} \cdot \vec{PQ}}{|\vec{PR}| |\vec{PQ}|}$  stated or implied by •7

•<sup>4</sup>  $\vec{PR} \cdot \vec{PQ} = 8$

•<sup>5</sup>  $|\vec{PR}| = \sqrt{14}$

•<sup>6</sup>  $|\vec{PQ}| = \sqrt{29}$

•<sup>7</sup>  $\hat{R}PQ = 66.6^\circ$  or  $1.163^\circ$

3 marks awarded : deduct 1 per error

3 Prove that the roots of the equation  $2x^2 + px - 3 = 0$  are real for all values of  $p$ .

4

Qu.	part	marks	Grade	Syllabus Code	Calculator class	Source
3		4	C,B	1.3.4, 1.1.6	CN	03/85

The Primary Method m/s is based on the following generic m/s.  
THIS GENERIC M/S MAY BE USED AS AN EQUIVALENCE GUIDE  
BUT ONLY WHERE A CANDIDATE DOES NOT USE THE PRIMARY  
METHOD OR ANY ALTERNATIVE METHOD SHOWN IN DETAIL IN  
THE MARKING SCHEME.

- <sup>1</sup> ss : know/use discriminant
- <sup>2</sup> ic : identify discriminant
- <sup>3</sup> pd : simplify
- <sup>4</sup> ic : complete proof

Primary Method : Give 1 mark for each •

- <sup>1</sup> *know to show  $b^2 - 4ac \geq 0$*
- <sup>2</sup>  $p^2 - 4 \times 2 \times (-3)$
- <sup>3</sup>  $p^2 + 24$
- <sup>4</sup>  $p^2$  is positive  
*so  $\Delta \geq 0$  and roots real*

4 marks

Note

- 1 Evidence for •<sup>1</sup> will more than likely appear at the •<sup>4</sup> stage.
- 2 Treat  $b^2 - 4ac > 0$  as bad form

1 Alternative Method 1

- <sup>1</sup>  $x = \frac{-p \pm \sqrt{(-p)^2 - 4 \times 2 \times (-3)}}{4}$
- <sup>2</sup>  $x = \frac{-p \pm \sqrt{p^2 + 24}}{4}$
- <sup>3</sup> *we need  $p^2 + 24 \geq 0$*
- <sup>4</sup>  $p^2$  is positive and so roots real

4 marks

- 4 A sequence is defined by the recurrence relation  $u_{n+1} = ku_n + 3$ .
- (a) Write down the condition on  $k$  for this sequence to have a limit. 1
- (b) The sequence tends to a limit of 5 as  $n \rightarrow \infty$ . Determine the value of  $k$ . 3

Qu.	part	marks	Grade	Syllabus Code	Calculator class	Source
4	a	1	C	1.4.3	CN	04/16
	b	3	B	1.4.3		

The Primary Method m/s is based on the following generic m/s.  
THIS GENERIC M/S MAY BE USED AS AN EQUIVALENCE GUIDE  
BUT ONLY WHERE A CANDIDATE DOES NOT USE THE PRIMARY  
METHOD OR ANY ALTERNATIVE METHOD SHOWN IN DETAIL IN  
THE MARKING SCHEME.

- <sup>1</sup> ic : state condition for limit
- <sup>2</sup> ss : know how to find limit
- <sup>3</sup> ic : substitute
- <sup>4</sup> pd : process

Primary Method : Give 1 mark for each •

- <sup>1</sup>  $-1 < k < 1$  1 mark
- <sup>2</sup>  $L = \frac{b}{1-a}$  *stated or implied by* •<sup>3</sup>
- <sup>3</sup>  $5 = \frac{3}{1-k}$
- <sup>4</sup>  $k = \frac{2}{5}$  3 marks

1 Alternative Method : no.1

- <sup>1</sup>  $-1 < k < 1$  1 mark
- <sup>2</sup>  $L = kL + 3$  *stated or implied by* •<sup>3</sup>
- <sup>3</sup>  $5 = 5k + 3$
- <sup>4</sup>  $k = \frac{2}{5}$  3 marks

Notes

- 1  $-1 \leq k \leq 1$  does not gain •<sup>1</sup>  
but  
accept “between -1 and 1” for •<sup>1</sup>  
accept  $|k| < 1$  for •<sup>1</sup>
- $-1 < a < 1$  does not gain •1 unless it has  
been replaced by  $k$  in subsequent working in  
(b)
- 2 Guess and check :  
Guessing  $k = 0.4$  and checking algebraically  
that this does yield a limit of 5 may be  
awarded 2 marks
- 3 Guess and check :  
Guessing  $k = 0.4$  and checking iteratively  
that this does yield a limit of 5 may be  
awarded 1 mark
- 4 No working :  
Simply stating that  $k = 0.4$  earns no marks
- 5 Wrong formula :  
Work using an incorrect “formula” leading to  
a valid value of  $k$  may be awarded 1 mark.

- 5 The point  $P(x, y)$  lies on the curve with equation  $y = 6x^2 - x^3$ .
- (a) Find the value of  $x$  for which the gradient of the tangent at P is 12. 5
- (b) Hence find the equation of the tangent at P. 2

Qu.	part	marks	Grade	Syllabus Code	Calculator class	Source
5	a	5	C	1.3.2, 1.3.9	CN	04/96
	b	2	C	1.1.6		

The Primary Method m/s is based on the following generic m/s.  
THIS GENERIC M/S MAY BE USED AS AN EQUIVALENCE GUIDE  
BUT ONLY WHERE A CANDIDATE DOES NOT USE THE PRIMARY  
METHOD OR ANY ALTERNATIVE METHOD SHOWN IN DETAIL IN  
THE MARKING SCHEME.

- <sup>1</sup> ss : know to differentiate
- <sup>2</sup> pd : differentiate
- <sup>3</sup> ss : set derivative = gradient
- <sup>4</sup> pd : start to solve
- <sup>5</sup> pd : process
- <sup>6</sup> pd : process
- <sup>7</sup> ic : state equation of tangent

Primary Method : Give 1 mark for each •

- <sup>1</sup>  $\frac{dy}{dx} =$  *stated or implied by* •2
- <sup>2</sup>  $12x - 3x^2$
- <sup>3</sup>  $12x - 3x^2 = 12$
- <sup>4</sup>  $3(x - 2)^2 = 0$
- <sup>5</sup>  $x = 2$  5 marks
- <sup>6</sup>  $y = 16$
- <sup>7</sup>  $y - 16 = 12(x - 2)$  2 marks

1 Common error no.1

- <sup>1</sup>  $\sqrt{\frac{dy}{dx}} =$  *stated or implied by* •2
- <sup>2</sup>  $\sqrt{12x - 3x^2}$
- <sup>3</sup>  $\times 12x - 3x^2 = 0$
- <sup>4</sup>  $\times 3x(4 - x)$
- <sup>5</sup>  $\times x = 0$  and  $x = 4$  2 marks awarded
- <sup>6</sup>  $\sqrt{x = 4} \Rightarrow y = 32$
- <sup>7</sup>  $\sqrt{y - 32} = 12(x - 4)$  2 marks awarded

Notes

1 For  $\frac{dy}{dx} = 12x - 3x^2$   
 $12x - 3x^2 = 12$

followed by a guess of  $x = 2$  and no check, only

•1,•2 and •3 can be awarded.

2 For  $\frac{dy}{dx} = 12x - 3x^2$   
 $12x - 3x^2 = 12$

followed by a guess of  $x = 2$  and a check that does

in fact yield 12, •1,•2,•3 and •4 can be awarded.

- 6 (a) Express  $3\cos(x^\circ) + 5\sin(x^\circ)$  in the form  $k\cos(x^\circ - a^\circ)$  where  $k > 0$  and  $0 \leq a \leq 90$ . 4
- (b) Hence solve the equation  $3\cos(x^\circ) + 5\sin(x^\circ) = 4$  for  $0 \leq x \leq 90$ . 3

Qu.	part	marks	Grade	Syllabus Code	Calculator class	Source
6	a	4	C	3.4.2	CR	04/122
6	b	3	B	3.4.2	CR	

The Primary Method m/s is based on the following generic m/s.  
THIS GENERIC M/S MAY BE USED AS AN EQUIVALENCE GUIDE  
BUT ONLY WHERE A CANDIDATE DOES NOT USE THE PRIMARY  
METHOD OR ANY ALTERNATIVE METHOD SHOWN IN DETAIL IN  
THE MARKING SCHEME.

- <sup>1</sup> ss : expand
- <sup>2</sup> ic : equate coefficients
- <sup>3</sup> pd : solve for  $k$
- <sup>4</sup> pd : solve for  $a$
- <sup>5</sup> ss : use transformed function
- <sup>6</sup> pd : solve trig equation for " $x - a$ "
- <sup>7</sup> pd : solve for  $x$

Primary Method : Give 1 mark for each •

- <sup>1</sup>  $k\cos x \cos a + k\sin x \sin a$  STATED EXPLICITLY
- <sup>2</sup>  $k\cos a = 3, k\sin a = 5$  STATED EXPLICITLY
- <sup>3</sup>  $k = \sqrt{34}$
- <sup>4</sup>  $a = 59$  4 marks
- <sup>5</sup>  $\sqrt{34}\cos(x - 59)^\circ = 4$
- <sup>6</sup>  $x - 59 = \text{any one of}$   
 $-46.7, 46.7, 313.3$
- <sup>7</sup>  $x = 12.3$  3 marks

Note

- 1 Using  $k\cos(x^\circ + a^\circ)$  etc:  
candidates may use any form of wave equation  
to start with, as long as their answer is in the  
form  $k\cos(x - a)$ .  
If it is not, then •<sup>4</sup> is not available.
- 2  $k(\cos x \cos a + \sin x \sin a)$  is OK for •<sup>1</sup>
- 3  $\sqrt{34}\cos x \cos a + \sqrt{34}\sin x \sin a$  is OK for •<sup>1</sup>
- 4 Treat  $k\cos x \cos a + \sin x \sin a$  as bad form  
provided •<sup>2</sup> is gained
- 5 Accept answers which round to 5.8 for  $k$  at •<sup>3</sup>
- 6 For •<sup>4</sup>, accept any answer which rounds to 59
- 7 Using  $k\cos a = 5, k\sin a = 3$ , leads to  $a = 31$ .  
Only marks •<sup>1</sup>, •<sup>3</sup> and •<sup>4</sup> are available

1 Alternative Method 1

- <sup>1</sup> strategy :  $r / a$  triangle  $3, 5, \sqrt{34}$
- <sup>2</sup>  $\sqrt{34}\left(\cos x \cdot \frac{3}{\sqrt{34}} + \sin x \cdot \frac{5}{\sqrt{34}}\right)$
- <sup>3</sup>  $\sqrt{34}(\cos x \cos a + \sin x \sin a)$  **and**  $\tan a = \frac{5}{3}$
- <sup>4</sup>  $a = 59^\circ$  4 marks

CONTINUED

6	(a)	Express $3\cos(x^\circ) + 5\sin(x^\circ)$ in the form $k\cos(x^\circ - a^\circ)$ where $k > 0$ and $0 \leq a \leq 90$ .	4
	(b)	Hence solve the equation $3\cos(x^\circ) + 5\sin(x^\circ) = 4$ for $0 \leq x \leq 90$ .	3

Qu.	part	marks	Grade	Syllabus Code	Calculator class	Source
6	a	4	C	3.4.2	CR	04/122
6	b	3	B	3.4.2	CR	

2	Common wrong solution	
• <sup>1</sup> ✓	$k\cos x \cos a + k\sin x \sin a$	STATED EXPLICITLY
• <sup>2</sup> ✗	$k\cos a = 5, k\sin a = 3$	STATED EXPLICITLY
• <sup>3</sup> ✓	$k = \sqrt{34}$	
• <sup>4</sup> ✓	$a = 31$	
• <sup>5</sup> ✓	$\sqrt{34}\cos(x - 31)^\circ = 4$	
• <sup>6</sup> ✓	$x - 31 = \text{any one of } 46.7, 313.3$	
• <sup>7</sup> ✗	$x = 77.7^\circ$	(this mark not awarded as working eased) so award 5 marks( 5 ticks)

3	Early rounding	
• <sup>1</sup> ✓	$k\cos x \cos a + k\sin x \sin a$	STATED EX.
• <sup>2</sup> ✓	$k\cos a = 3, k\sin a = 5$	STATED EX.
• <sup>3</sup> ✓	$k = 5.8$	
• <sup>4</sup> ✓	$a = 59$	
• <sup>5</sup> ✓	$6\cos(x - 59)^\circ = 4$	
• <sup>6</sup> ✓	$x - 59 = \text{any one of } -48.2, 48.2, 311.8$	
• <sup>7</sup> ✓	$x = 10.8^\circ$	so award 7 marks( 7 ticks)

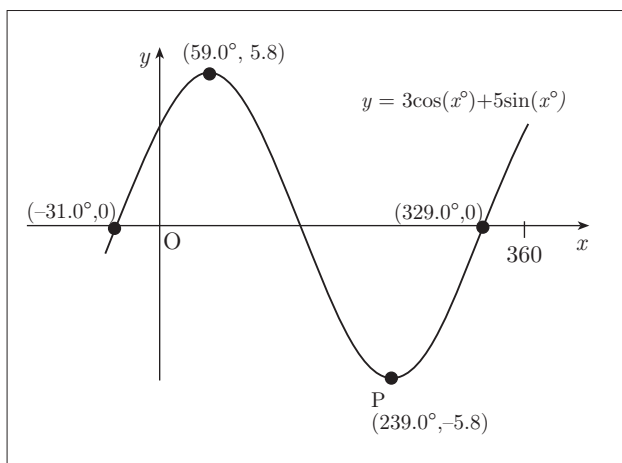

Alternative Method 2		via a Graphics Calculator
• <sup>1</sup>	annotated on diagram	max at $(59.0, 5.8)$ and min at $(239.0, -5.8)$
• <sup>2</sup>	annotated on diagram	$(-31.0, 0)$ or $(149.0, 0)$ or $(329.0, 0)$
• <sup>3</sup>	"from the amplitude $k = 5.8$ "	
• <sup>4</sup>	"from the shift $a = 59.0$ "	
		4 marks
• <sup>5</sup>	communication : eg solution will be where $y = 4$ meets the graph	
• <sup>6</sup>	annotated on diagram	the line with equation $y = 4$
• <sup>7</sup>	intersection gives $x = 12.3$	
		3 marks

7 The graph of the cubic function  $y = f(x)$  is shown in the diagram. There are turning points at  $(1, 1)$  and  $(3, 5)$ .  
Sketch the graph of  $y = f'(x)$ .

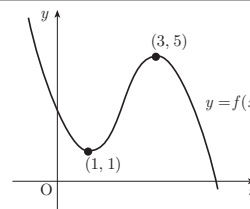

3

Qu.	part	marks	Grade	Syllabus Code	Calculator class	Source
7		3	B	1.3.13	CN	04/87

The Primary Method m/s is based on the following generic m/s. THIS GENERIC M/S MAY BE USED AS AN EQUIVALENCE GUIDE BUT ONLY WHERE A CANDIDATE DOES NOT USE THE PRIMARY METHOD OR ANY ALTERNATIVE METHOD SHOWN IN DETAIL IN THE MARKING SCHEME.

- <sup>1</sup> ic : interpret stationary points
- <sup>2</sup> ic : interpret between roots
- <sup>3</sup> ic : know  $f'(cubic) = parabola$

Primary Method : Give 1 mark for each •

a sketch with the following details

- <sup>1</sup> *only two intercepts on the x - axis at 1 and 3*
- <sup>2</sup> *function is + ve between the roots and - ve outwith*
- <sup>3</sup> *a parabola (symmetrical about midpoint of x - intercepts), stated or implied by the accuracy of the diagram*

3 marks

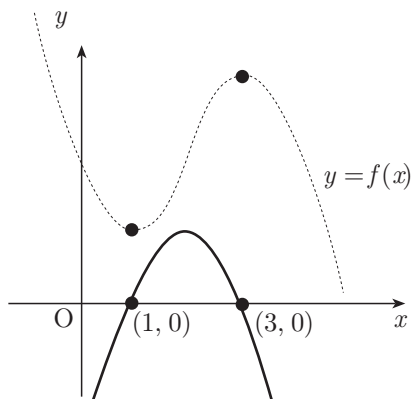

Note

- 1 The evidence for •<sup>1</sup> may be on a diagram or in a table or in words
- 2 For •<sup>3</sup>, with the intercepts unknown, they must lie on the positive branch of the x-axis
- 3 For a parabola passing through  $(1, 1)$  and  $(3, 5)$  award **ONLY 1 MARK**.



8 The circle with centre A has equation  $x^2 + y^2 - 12x - 2y + 32 = 0$ . The line PT is a tangent to this circle at the point P(5, -1).

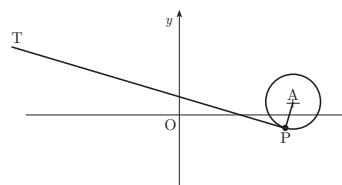

(a) Show that the equation of this tangent is  $x + 2y = 3$ .

The circle with centre B has equation  $x^2 + y^2 + 10x + 2y + 6 = 0$ .

(b) Show that PT is also a tangent to this circle.

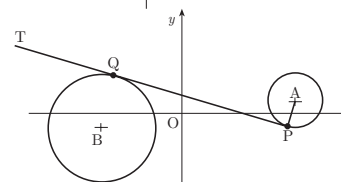

(c) Q is the point of contact. Find the length of PQ.

4  
5  
2

Qu.	part	marks	Grade	Syllabus Code	Calculator class	Source
8	a	4	C	2.4.2, 2.4.4	CN	04/113
	b	5	C	2.1.8		
	c	2	C	1.1.1		

The Primary Method m/s is based on the following generic m/s. THIS GENERIC M/S MAY BE USED AS AN EQUIVALENCE GUIDE BUT ONLY WHERE A CANDIDATE DOES NOT USE THE PRIMARY METHOD OR ANY ALTERNATIVE METHOD SHOWN IN DETAIL IN THE MARKING SCHEME.

- <sup>1</sup> ic : interpret circle equation
- <sup>2</sup> ic : find gradient
- <sup>3</sup> ss : know/find perpendicular gradient
- <sup>4</sup> pd : complete proof
- <sup>5</sup> pd : start solving process
- <sup>6</sup> ss : know/substitute
- <sup>7</sup> pd : arrange in standard form
- <sup>8</sup> ss : know how to justify tangency
- <sup>9</sup> ic : complete proof
- <sup>10</sup> ic : interpret solution from (b)
- <sup>11</sup> pd : process distance formula

Primary Method : Give 1 mark for each •

- <sup>1</sup>  $A(6,1)$
- <sup>2</sup>  $m_{AP} = 2$  *STATED EXPLICITLY*
- <sup>3</sup>  $m_{PQ} = -\frac{1}{2}$
- <sup>4</sup>  $y + 1 = -\frac{1}{2}(x - 5)$  and complete 4 marks
- <sup>5</sup>  $x = 3 - 2y$
- <sup>6</sup>  $(3 - 2y)^2 + y^2 + 10(3 - 2y) + 2y + 6 = 0$
- <sup>7</sup>  $5y^2 - 30y + 45 = 0$
- <sup>8</sup> solve and get double root  $\Rightarrow$  tangent
- <sup>9</sup>  $5(y - 3)^2 = 0$  5 marks
- <sup>10</sup>  $Q = (-3, 3)$
- <sup>11</sup>  $PQ = \sqrt{80}$  2 marks

1 Alternative method for •1 to •4

- <sup>1</sup>  $(3 - 2y)^2 + y^2 - 12(3 - 2y) - 2y + 32 = 0$
- <sup>2</sup>  $5(y + 1)^2 = 0$
- <sup>3</sup> double root  $\Rightarrow$  tangent
- <sup>4</sup>  $x = 3 - 2y = 3 - 2 \times (-1) = 5$  4 marks

Notes

- 1 •<sup>3</sup> is **ONLY AVAILABLE** if •<sup>2</sup> has been awarded.
- 2 •<sup>4</sup> is only available if an attempt has been made to find a perpendicular gradient
- 3 completion at •<sup>4</sup> :  
the minimum acceptable would be

$$y + 1 = -\frac{1}{2}(x - 5)$$

$$2y + 2 = -x + 5$$

$$2y + x = 3$$

8 The circle with centre A has equation  $x^2 + y^2 - 12x - 2y + 32 = 0$ . The line PT is a tangent to this circle at the point P(5, -1).

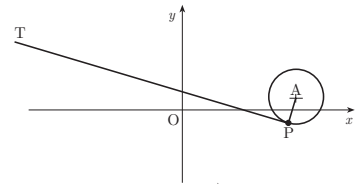

(a) Show that the equation of this tangent is  $x + 2y = 3$ .

The circle with centre B has equation  $x^2 + y^2 + 10x + 2y + 6 = 0$ .

(b) Show that PT is also a tangent to this circle.

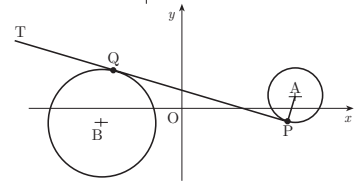

(c) Q is the point of contact. Find the length of PQ.

4

5

2

Notes cont

4 An “= 0” must appear at either the •<sup>6</sup> or •<sup>7</sup> stage. Failure to appear will forfeit one of these marks.

5 Evidence for (b) may appear in the working for (c)

1	Alternative for •8 and •9
• <sup>8</sup>	<i>use discriminant, and get zero ⇒ tangent</i>
• <sup>9</sup>	$b^2 - 4ac = (-30)^2 - 4.5.45 = 0$

2	Alternative for (c) (•10 and •11)
• <sup>8</sup>	$BP = 10 \text{ units}, BQ = \text{radius} = \sqrt{20} \text{ units}$
• <sup>9</sup>	<i>by Pythagoras</i> $PQ = \sqrt{80}$

3	Alternative Method for (b) (•5 to •9)
• <sup>5</sup>	$y = \frac{1}{2}(3 - x)$
• <sup>6</sup>	$(x)^2 + \left(\frac{1}{2}(3 - x)\right)^2 + 10(x) + 2\left(\frac{1}{2}(3 - x)\right) + 6 = 0$
• <sup>7</sup>	$5x^2 + 30x + 45 = 0$
• <sup>8</sup>	$5(x + 3)^2 = 0$
• <sup>9</sup>	<i>double root ⇒ tangency</i> <i>or</i> $b^2 - 4ac = 900 - 4.5.45 ⇒ \text{tangency}$
	5 marks

4	Alternative Method for (b) (•5 to •9)
• <sup>5</sup>	<i>centre</i> $B = (-5, -1)$
• <sup>6</sup>	<i>diam</i> : $y + 1 = 2(x + 5)$
• <sup>7</sup>	$2x + 9 = \frac{3 - x}{2}$
• <sup>8</sup>	$Q = (-3, 3)$
• <sup>9</sup>	<i>check</i> : $9 + 9 - 30 + 6 + 6 = 0$
	5 marks

5	Common error for (b)
• <sup>5</sup>	$\times \quad x = 2y - 3$
• <sup>6</sup>	$\sqrt{(2y - 3)^2 + y^2 + 10(2y - 3) + 2y + 6 = 0}$
• <sup>7</sup>	$\sqrt{5y^2 + 10y - 15 = 0}$
• <sup>8</sup>	$\sqrt{5(y + 3)(y - 1) = 0}$
• <sup>9</sup>	$\sqrt{\text{intersects in two pts } (y=1 \text{ and } y=-3) ⇒ \text{not a tgt}}$
	4 marks awarded

9 An open cuboid measures internally  $x$  units by  $2x$  units by  $h$  units and has an inner surface area of  $12 \text{ units}^2$ .

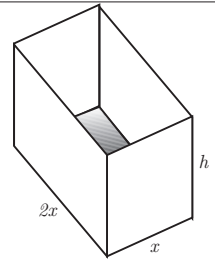

(a) Show that the volume,  $V \text{ units}^3$ , of the cuboid is given by

$$V(x) = \frac{2}{3}x(6 - x^2).$$

(b) Find the exact value of  $x$  for which this volume is a maximum.

3  
5

Qu.	part	marks	Grade	Syllabus Code	Calculator class	Source
9	a	3	AB	1.3.15	CN	04/n
	b	5	C	1.3.15		

The Primary Method m/s is based on the following generic m/s. THIS GENERIC M/S MAY BE USED AS AN EQUIVALENCE GUIDE BUT ONLY WHERE A CANDIDATE DOES NOT USE THE PRIMARY METHOD OR ANY ALTERNATIVE METHOD SHOWN IN DETAIL IN THE MARKING SCHEME.

- <sup>1</sup> ss : use area facts
- <sup>2</sup> ss : use volume facts
- <sup>3</sup> ic : complete proof
- <sup>4</sup> pd : arrange in standard form
- <sup>5</sup> pd : differentiate
- <sup>6</sup> ss : set derivative to zero
- <sup>7</sup> pd : process
- <sup>8</sup> ic : justification

Primary Method : Give 1 mark for each •

- <sup>1</sup>  $A = 2x^2 + 2xh + 4xh = 12$
- <sup>2</sup>  $V = 2x \times x \times h$
- <sup>3</sup>  $V = 2x \times \frac{12-2x^2}{6} = \& \text{ complete}$

3 marks

- <sup>4</sup>  $V = 4x - \frac{2}{3}x^3$
- <sup>5</sup>  $\frac{dV}{dx} = 4 - 2x^2$
- <sup>6</sup>  $\frac{dV}{dx} = 0$  STATED EXPLICITLY
- <sup>7</sup>  $x = \sqrt{2}$
- <sup>8</sup>

$x$	$< \sqrt{2}$	$\sqrt{2}$	$> \sqrt{2}$
$\frac{dV}{dx}$	$+ve$	$0$	$-ve$
$tgt$	$/$	$-$	$\backslash$

max

5 marks

Alternative for •1, •2 and •3

- <sup>1</sup>  $2x^2 + 2xh + 4xh = 12$
- <sup>2</sup>  $h = \frac{12-2x^2}{6x}$
- <sup>3</sup>  $V = 2x \times x \times \frac{12-2x^2}{6x} = \& \text{ complete}$

3 marks

Notes

- 1 Do not penalise the non-appearance of  $-\sqrt{2}$  at the •<sup>7</sup> stage.
- 2  $\frac{d^2V}{dx^2} = -4x < 0 \Rightarrow$  maximum may be accepted for •<sup>8</sup>.

- 10 The amount  $A_t$  micrograms of a certain radioactive substance remaining after  $t$  years decreases according to the formula  $A_t = A_0 e^{-0.002t}$ , where  $A_0$  is the amount present initially.
- (a) If 600 micrograms are left after 1000 years, how many micrograms were present initially? **3**
- (b) The half-life of a substance is the time taken for the amount to decrease to half of its initial amount. What is the half-life of this substance? **4**

Qu.	part	marks	Grade	Syllabus Code	Calculator class	Source
10	a	3	C	3.3.4	CR	04/121
	b	4	AB	3.3.4		

The Primary Method m/s is based on the following generic m/s. THIS GENERIC M/S MAY BE USED AS AN EQUIVALENCE GUIDE BUT ONLY WHERE A CANDIDATE DOES NOT USE THE PRIMARY METHOD OR ANY ALTERNATIVE METHOD SHOWN IN DETAIL IN THE MARKING SCHEME.

- <sup>1</sup> ss : substitute
- <sup>2</sup> pd : change the subject
- <sup>3</sup> pd : process exponential power
- <sup>4</sup> ic : interpret half life
- <sup>5</sup> pd : process
- <sup>6</sup> ss : switch to logarithmic form
- <sup>7</sup> pd : solve logarithmic equation

Primary Method : Give 1 mark for each •

- <sup>1</sup>  $600 = A_0 e^{-0.002 \times 1000}$
- <sup>2</sup>  $A_0 = \frac{600}{e^{-0.002 \times 1000}}$
- <sup>3</sup> 4433 3 marks
- <sup>4</sup>  $\frac{1}{2} A_0 = A_0 e^{-0.002t}$
- <sup>5</sup>  $0.5 = e^{-0.002t}$
- <sup>6</sup>  $-0.002t = \ln 0.5$
- <sup>7</sup>  $t = 347$  years 4 marks

1 Alternative method for (a)

- <sup>1</sup>  $600 = A_0 e^{-0.002 \times 1000}$
- <sup>2</sup>  $\ln A_0 = \ln 600 - \ln e^{-0.002 \times 1000}$
- <sup>3</sup>  $A_0 = 4433$  3 marks

Notes

- 1 Accept any correct answer which rounds to 4430.  
For any other answer, rounding must be indicated.
- 2 A trial and improvement approach :  
For  $600 = A_0 e^{-2}$  award •<sup>1</sup>  
For eg  $4000e^{-2} = 541$   
 $4500e^{-2} = 609$   
leading to an answer which rounds to 4430, award •<sup>3</sup>
- 3 At •<sup>4</sup>,  $A_0$  may be replaced by any real number
- 4 For (b) an answer obtained by trial and improvement which rounds to 346 or 347 may be awarded 1 mark.

11 An architectural feature of a building is a wall with arched windows. The curved edge of each window is parabolic. The second diagram shows one such window. The shaded part represents the glass. The top edge of the window is part of the parabola with equation  $y = 2x - \frac{1}{2}x^2$ . Find the area in square metres of the glass in one window.

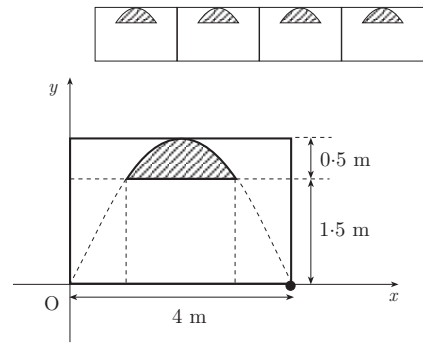

8

Qu.	part	marks	Grade	Syllabus Code	Calculator class	Source
11		8	A	2.1.0, 2.1.9	CN	04/110

The Primary Method m/s is based on the following generic m/s. THIS GENERIC M/S MAY BE USED AS AN EQUIVALENCE GUIDE BUT ONLY WHERE A CANDIDATE DOES NOT USE THE PRIMARY METHOD OR ANY ALTERNATIVE METHOD SHOWN IN DETAIL IN THE MARKING SCHEME.

- <sup>1</sup> ss : find intersections
- <sup>2</sup> pd : process quadratic to solution
- <sup>3</sup> ss : decide on appropriate areas
- <sup>4</sup> ss : know to integrate
- <sup>5</sup> ic : state limits
- <sup>6</sup> pd : integrate
- <sup>7</sup> pd : evaluate using limits
- <sup>8</sup> pd : evaluate area

Primary Method : Give 1 mark for each •

- <sup>1</sup>  $2x - \frac{1}{2}x^2 = 1.5$
- <sup>2</sup>  $x = 1, x = 3$
- <sup>3</sup> "split area up" *stated or implied by* •<sup>4</sup>
- <sup>4</sup>  $\int \left(2x - \frac{1}{2}x^2 - \frac{3}{2}\right) dx$
- <sup>5</sup>  $\int_1^3 \dots dx$
- <sup>6</sup>  $\left[x^2 - \frac{1}{6}x^3 - \frac{3}{2}x\right]_1^3$
- <sup>7</sup>  $\left(3^2 - \frac{1}{6} \cdot 3^3 - \frac{3}{2} \cdot 3\right) - \left(1^2 - \frac{1}{6} \cdot 1^3 - \frac{3}{2} \cdot 1\right)$
- <sup>8</sup>  $\frac{2}{3}$

8 marks

Notes

- 1 The first two marks may be obtained as follows:  
 Guess  $x = 1$  and check that  $y = 1.5$ , award •<sup>1</sup>  
 Guess  $x = 3$  and check that  $y = 1.5$ , award •<sup>2</sup>
- 2 In the Primary method, •<sup>3</sup> is clearly not available for subtracting the wrong way round.  
 •<sup>8</sup> will also be lost for statements such as  
 $-\frac{2}{3} = \frac{2}{3}$   
 $-\frac{2}{3}$  so ignore the negative  
 $-\frac{2}{3} = \frac{2}{3}$  squ units  
 •<sup>8</sup> can still be gained for statements such as  
 $\dots - \frac{2}{3}$  and so the area =  $\frac{2}{3}$

1 Alternative Method

- <sup>1</sup>  $2x - \frac{1}{2}x^2 = 1.5$
- <sup>2</sup>  $x = 1, x = 3$
- <sup>3</sup>  $\int \left(2x - \frac{1}{2}x^2\right) dx$
- <sup>4</sup> choose limits,  $a$  and  $b$ :  $0 \leq a \leq b \leq 4$
- <sup>5</sup>  $\left[x^2 - \frac{1}{6}x^3\right]$
- <sup>6</sup> evaluate  $\left[x^2 - \frac{1}{6}x^3\right]_a^b$  for chosen values of  $a$  and  $b$
- <sup>7</sup> state areas to be added/subtracted *st / imp by* •<sup>8</sup>
- <sup>8</sup>  $\frac{2}{3}$

8 marks

S1 A die has three red faces, two blue faces and one yellow face. An experiment consists of noting the uppermost colour after a roll of the die.

Random Numbers

2 7 9 8 9    6 4 7 2 8    1 0 7 4 4    0 8 3 9 6    5 6 2 4 2  
 9 0 9 8 5    2 8 8 6 8    9 9 4 3 1    5 0 9 9 5    2 0 5 0 7

- (a) Use the given random numbers to simulate 18 trials of the experiment. Explain your strategy. **2**
- (b) How closely do the results of your simulation agree with the theoretical probability of obtaining blue? **2**

*replacing qu.2*

Qu.	part	marks	Grade	Syllabus Code	Calculator class	Source
S1	a	2	C	4.2	CR	04/124
	b	2	C	4.2		

The Primary Method m/s is based on the following generic m/s. THIS GENERIC M/S MAY BE USED AS AN EQUIVALENCE GUIDE BUT ONLY WHERE A CANDIDATE DOES NOT USE THE PRIMARY METHOD OR ANY ALTERNATIVE METHOD SHOWN IN DETAIL IN THE MARKING SCHEME.

- <sup>1</sup> ic : define simulation
- <sup>2</sup> pd : process simulation
- <sup>3</sup> pd : find probability
- <sup>4</sup> ic : comment

Primary Method : Give 1 mark for each •

- <sup>1</sup> define simulation
- <sup>2</sup> results of simulation
- <sup>3</sup>  $P(\text{blue}_{\text{theoretical}}) = \frac{1}{3}$
- <sup>3</sup> cf simulation  $P(\text{blue}_{\text{experimental}})$  with  $\frac{1}{3}$

*4 marks*

S2 As part of a study on intensive exercise, a sports scientist recorded the peak heart rates of a random selection of sixteen volunteers of different ages who took regular exercise. The linear regression equation was calculated for the data shown in the scatter diagram and found to be  $y = 209 - 0.727x$ .

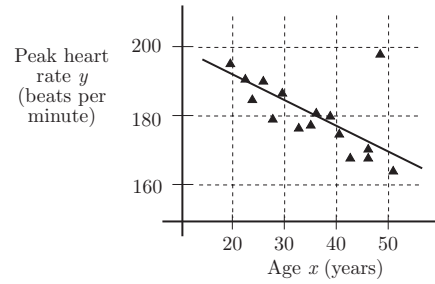

However after considering the scatter diagram for the data, it was realised that one piece of data had been misrecorded and this volunteer's data was ignored.

- (a) State the approximate age of the volunteer whose data was ignored. 1
- (b) Calculate the new regression equation using the values  $\Sigma x = 509, \Sigma x^2 = 18\,477, \Sigma y = 2738, \Sigma y^2 = 501\,192, \Sigma xy = 91\,694$ . 6
- (c) Comment on the difference this makes to the prediction for the average peak heart rate of a 45 year old volunteer. 2

replacing qu.6

Qu.	part	marks	Grade	Syllabus Code	Calculator class	Source
S2	a	1	B	4.4.2	CR	04/131
	b	6	B	4.4.2		
	c	2	A	4.4.2		

The Primary Method m/s is based on the following generic m/s. THIS GENERIC M/S MAY BE USED AS AN EQUIVALENCE GUIDE BUT ONLY WHERE A CANDIDATE DOES NOT USE THE PRIMARY METHOD OR ANY ALTERNATIVE METHOD SHOWN IN DETAIL IN THE MARKING SCHEME.

- <sup>1</sup> ic : estimate from graph
- <sup>2</sup> ic : state  $n$
- <sup>3</sup> pd : process
- <sup>4</sup> pd : process
- <sup>5</sup> pd : determine regression coefficients
- <sup>6</sup> pd : determine regression coefficients
- <sup>7</sup> ic: state regression equation
- <sup>8</sup> pd : use regression equation
- <sup>9</sup> ic : interpret results

Primary Method : Give 1 mark for each •

- <sup>1</sup> 48 1 mark
- <sup>2</sup>  $n = 15$
- <sup>3</sup>  $S_{xx} = 1204.93$
- <sup>4</sup>  $S_{xy} = -1215.47$
- <sup>5</sup>  $a = 217$
- <sup>6</sup>  $b = -1.01$
- <sup>7</sup>  $y = 217 - 1.01x$  6 marks
- <sup>8</sup>  $est_{old} = 176, est_{new} = 172$
- <sup>9</sup> removing outlier improves estimate 2 marks

- S3 The selection procedure for a Police force consists of 3 independent tests, Intelligence(I), Fitness (F) and Communication(C). The outcome of each test is an independent event and is either pass or fail. A candidate must pass all three tests to enter training. It has been established that the probability of failing each test is as follows:

Test	I	F	C
P(failing)	0.2	0.6	0.3

- (a) Calculate the probability that a candidate will be selected for training. **2**
- (b) Five candidates are being tested for selection. Find the probability that
- (i) all five candidates will be accepted
- (ii) all five candidates will be rejected. **3**

*replacing qu.10*

Qu.	part	marks	Grade	Syllabus Code	Calculator class	Source
S3	a	2	B	4.2.7	CN	04/126
	b	32	B	4.2.10		

The Primary Method m/s is based on the following generic m/s.  
THIS GENERIC M/S MAY BE USED AS AN EQUIVALENCE GUIDE  
BUT ONLY WHERE A CANDIDATE DOES NOT USE THE PRIMARY  
METHOD OR ANY ALTERNATIVE METHOD SHOWN IN DETAIL IN  
THE MARKING SCHEME.

- <sup>1</sup> ss : use approp. strategy P(Pass) or  $1 - P(\text{fail})$
- <sup>2</sup> pd : process
- <sup>3</sup> pd : process all pass
- <sup>4</sup> pd : process one fail
- <sup>5</sup> pd : process all fail

Primary Method : Give 1 mark for each •

- <sup>1</sup>  $P(\text{selected}) = 0.8 \times 0.4 \times 0.7$
- <sup>2</sup>  $0.224 \text{ or } \frac{28}{125}$  *2 marks*
- <sup>3</sup>  $0.224^5 = 0.000564$
- <sup>4</sup>  $P(1 \text{ not selected}) = 0.776$
- <sup>5</sup>  $0.776^5 = 0.281$  *3 marks*



S4 Show that the diagram represents a probability density function for a continuous random variable  $X$ .

*replacing qu.10*

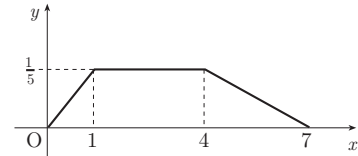

**3**

Qu.	part	marks	Grade	Syllabus Code	Calculator class	Source
S4		3	A	4.3.4	CN	04/129

The Primary Method m/s is based on the following generic m/s.  
THIS GENERIC M/S MAY BE USED AS AN EQUIVALENCE GUIDE  
BUT ONLY WHERE A CANDIDATE DOES NOT USE THE PRIMARY  
METHOD OR ANY ALTERNATIVE METHOD SHOWN IN DETAIL IN  
THE MARKING SCHEME.

- <sup>1</sup> ic : state requirement for pdf
- <sup>2</sup> ic : state requirement for pdf
- <sup>3</sup> pd : complete proof

Primary Method : Give 1 mark for each •

- <sup>1</sup> function above  $x -$  axis
- <sup>2</sup> total area must be 1
- <sup>3</sup>  $\frac{1}{2} \times 1 \times \frac{1}{5} + 3 \times \frac{1}{5} + \frac{1}{2} \times 3 \times \frac{1}{5}$   
 $= \frac{1}{10} + \frac{6}{10} + \frac{3}{10} = 1$

*3 marks*